

CLEARANCES & INSTALLATION MANUAL BIOETHANOL ONLY

Please read these instructions and the Burner Operations Manual provided with your burner completely before operating the appliance.

REFER TO THE OPERATIONS MANUAL IN THE BURNER PACKAGING FOR CLEARANCE AND INSTALLATION INSTRUCTIONS IF USING PROPANE OR NATURAL GAS.

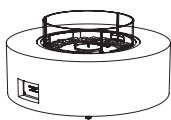

Ark 40
Concrete 63kg, 138.7lbs

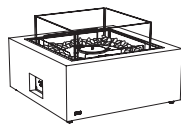

Base 30
Concrete 62.1kg, 136.7lbs
Teak 43.8kg, 96.4lbs

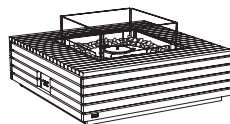

Base 40
Concrete 79.4kg, 174.7lbs
Teak 56.8kg, 125lbs

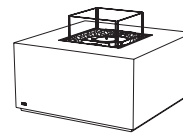

Chaser 38
Concrete 83kg, 182.7lbs

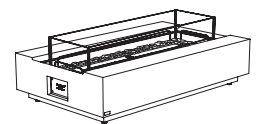

Cosmo 50
Concrete 76.3kg, 167.9lbs
Teak 58.8kg, 129.4lbs

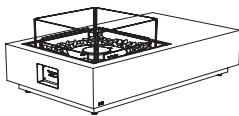

Manhattan 50
Concrete 58.4kg, 128.5lbs
Teak 52.8kg, 116.2lbs

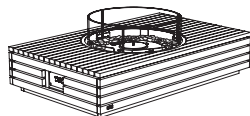

Martini 50
Concrete 53.2kg, 117.1lbs
Teak 47.2kg, 103.9lbs

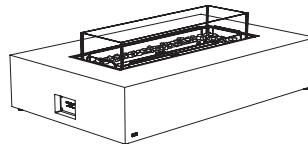

Wharf 65
Concrete 113.3kg, 249.3lbs
Teak 87.3kg, 192.1lbs

e-nrg[®]
natural . renewable . green

e-NRG is the ONLY fuel to
be used in this appliance.

www.e-nrg.com
www.e-nrg.com.au

! WARNINGS:

IF THE INFORMATION IN THIS MANUAL IS NOT FOLLOWED EXACTLY, A FIRE OR EXPLOSION MAY RESULT CAUSING PROPERTY DAMAGE, PERSONAL INJURY OR LOSS OF LIFE.



Do not fill
while hot



Do not fill while
operating



Do not overfill



Flammable

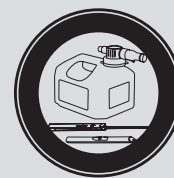

Use with supplied
accessories



Keep away
from children

Fireplace Clearances

When using Bioethanol as a fuel source this model is suitable for indoor and outdoor use.

Before installation ensure that the model is positioned in accordance with the compulsory minimum clearances outlined below.

If used indoors ensure that you pay attention to the Minimum Room Sizes below:

AB8/ AB8(EN)	116m ³ [4096ft ³] per burner
XL900	110m ³ [3884ft ³] per burner

WARNING: Ensure that your fire is positioned away from flammable materials and other sources of ignition at all times. Pay very close attention to positioning the fire away from items that may move as a result of wind and drafts. For example trees/branches/paper and the like.

The base of the burner within the model must never come into direct contact with flammable materials.

Side clearances to fixed and stable furniture items that are not susceptible to movement (e.g lounges or patio furniture) must remain a minimum of 600mm [23.6in] away from the flame at all times.

Overhead clearances to items that are susceptible to movement (e.g. Trees) must remain a minimum of 2000mm [78.7in] away from the flame at all times.

These products feature 360° height-adjustable articulating feet. Adjust the feet by turning them in either direction until you achieve a perfectly level and stable model before operating.

Stainless steel will rust or corrode over time if contamination or debris is not cleaned or removed immediately. Always use the Burner Lid included with your model to avoid dust and debris from accumulating inside the burner.

If you live in extreme weather conditions where accumulation of snow is likely, use of the Winter Bag is imperative in order to be covered by the warranty.

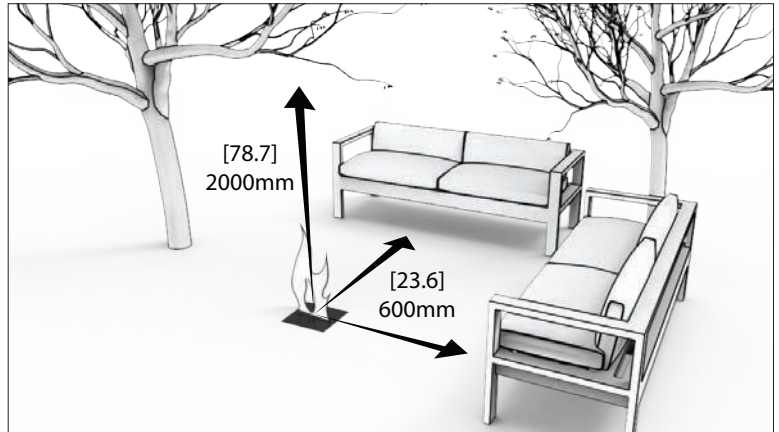

1. Outdoor Clearances

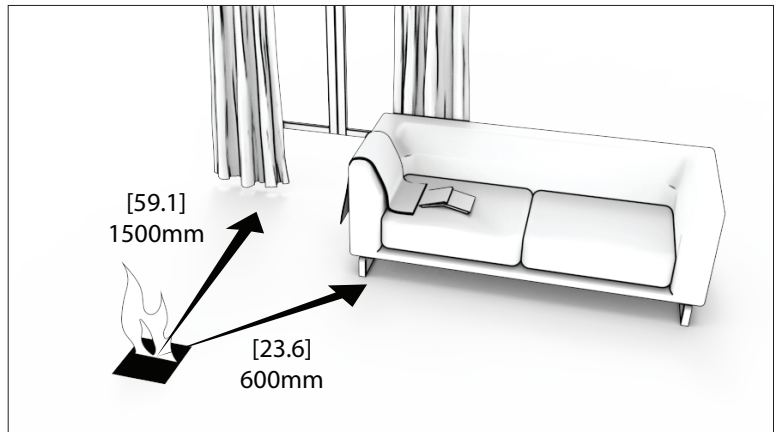

2. Indoor Clearances

Fireplace Installation

1. Insert the metal tray into the base.

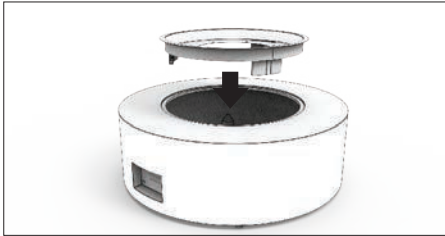
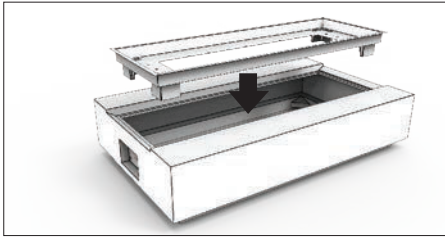

2. For Indoor Installations insert the Indoor Safety Tray. The appliance must not be operated indoors without the Safety Tray installed.

For outdoor installation go to Step 3.

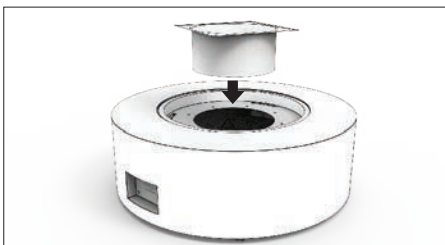
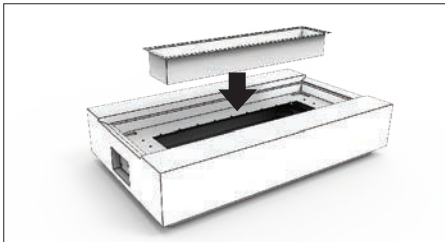

3. Insert Burner into metal tray.

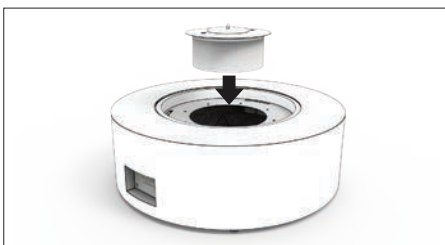
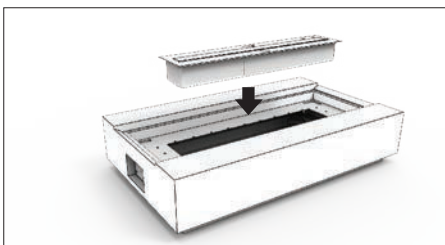

4. Insert Glass Screen. (If applicable).

Align each glass screen tab with the designated slots in the metal tray, gently put into position. Exercise caution so as not to fracture or damage glass.

If included as a standard part (compulsory in the USA), the appliance must not be operated without the glass screen installed.

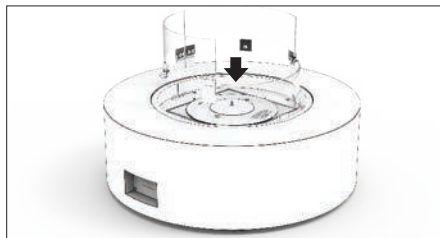
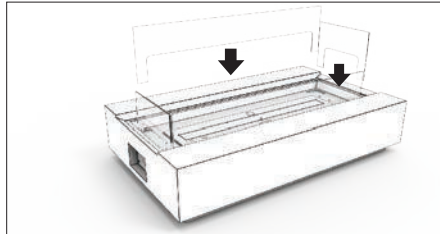

Chaser 38 Round Glass Screen Installation

4a. Ensure all corner covers are on.

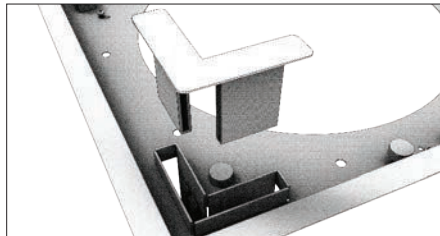

4b. Install the three (3) glass support metal brackets.

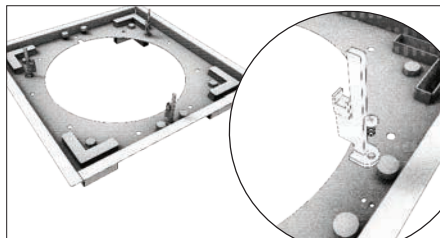

4c. Insert burner into the model. Add glass charcoal around the burner - be careful not to scratch the burner surface.

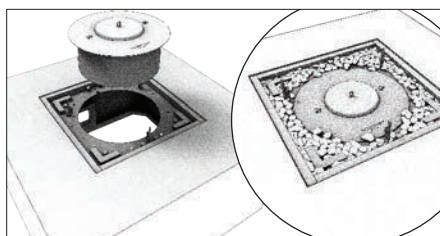

4d. Carefully place the glass fire screen onto the three (3) metal brackets. Ensure bumpers are intact on the brackets to prevent damaging the glass fire screen.

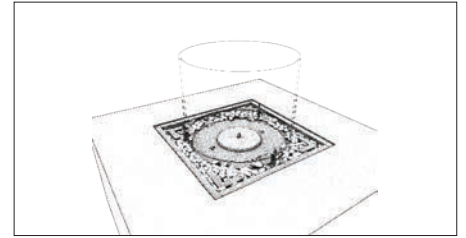

5. Add glass charcoal around the burner - be careful not to scratch the burner surface.

Do not place glass charcoal on top of the burner or where they can interfere with the operation of the burner or the flame.

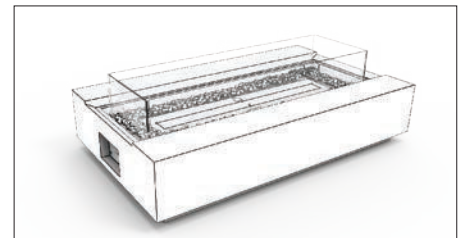

These models come with Ground Fixing Brackets so they can be installed in a fixed position. Follow the instructions supplied with the Ground Fixing Brackets to complete the installation of the product.

OPERATE ACCORDING TO THE BURNER OPERATIONS MANUAL INCLUDED WITH THE BURNER.

Abstände zur Feuerstelle

Bitte lesen Sie diese Anleitung sowie die Gebrauchsanleitung, die Sie mit dem Brenner erhalten haben sorgfältig und komplett durch, bevor Sie Ihre Feuerstelle in Betrieb nehmen. **ALLE ABSTÄNDE UND INSTALLATIONSANWEISUNGEN FÜR DIE VERWENDUNG VON PROPAN- ODER ERDGAS FINDEN SIE IN DER BEDIENUNGSANLEITUNG DES BRENNERS.**

Diese Modelle eignen sich nur für den Einsatz im Freien / Outdoor.

Vor der Installation stellen Sie sicher, dass die Feuerstelle gem. den unten benannten erforderlichen Mindest-Abständen platziert wurde.

Bei der Verwendung in Innenräumen, bitte die Mindest-Raumgröße beachten, siehe unten:

AB8/ AB8(EN)	116m ³ [4096ft ³] pro Brenner
XL900	110m ³ [3884ft ³] pro Brenner

ACHTUNG: Stellen Sie sicher, dass das Feuer jederzeit in sicherem Abstand von brennbaren und leicht entflammaren Materialien positioniert ist. Achten Sie v.a. darauf, dass das Feuer in sicherer Entfernung von beweglichen bzw. windanfälligen Gegenständen oder Materialien aufgestellt wird, wie z.B. Pflanzen, Bäumen, Vorhängen, Papierdekorationen o.Ä.

Die Unterseite des Burners darf niemals und zu keiner Zeit mit brennbaren bzw. leicht entflammaren Materialien in Berührung kommen.

Der seitliche Abstand der Flamme zu schweren bzw. fest platzierten Einrichtungsgegenständen, die nur unter hohem Aufwand bewegt werden können, wie z.B. Lounge- oder Terrassen-Möbel, sollte mindestens 600mm (23.6 inch) betragen.

Der Mindest-Abstand der Flamme zu leichten, wind- und bewegungsanfälligen Stoffen oder Dingen (wie Ästen, Bäumen o.Ä.) muss jederzeit 2000 mm [78.2 in] betragen.

Diese Modelle verfügen über 360° höhenverstellbare Füßchen. Bevor Sie die Feuerstelle in Betrieb nehmen, stellen Sie die entsprechende Höhe der Füßchen durch Drehen in die eine oder andere Richtung ein, bis das Modell sicher und stabil in der Waage platziert wurde.

Edelstahl korrodiert bzw. rostet mit der Zeit, falls Verschmutzungen oder Nässe nicht unmittelbar entfernt werden. Verwenden Sie stets, die mit Ihrem Modell mitgelieferte Burner-Abdeckung, damit Staub und Ablagerung innerhalb des Burners vermieden werden.

Sollten extreme Witterungsbedingungen vorherrschen und Schnee wahrscheinlich sein, so ist die Benutzung der Wintertasche vorgeschrieben, damit die Garantie nicht erlischt.

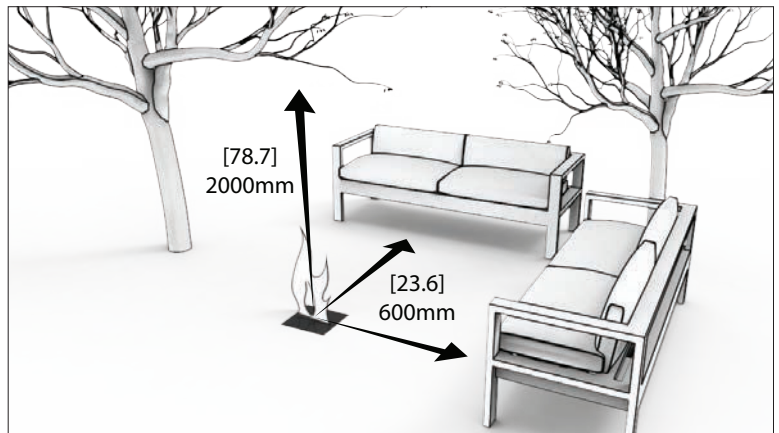

Sicherheitsabstände im Außenbereich

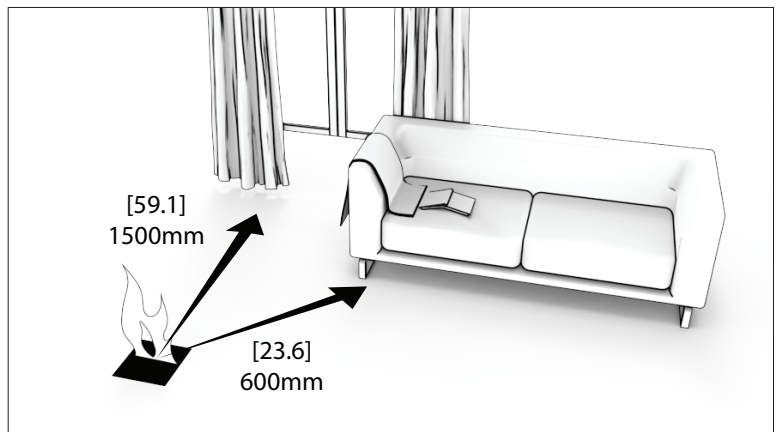

Sicherheitsabstände im Innenbereich

Installation der Feuerstelle

1. Setzen Sie das Metallblech in die Halterung ein.

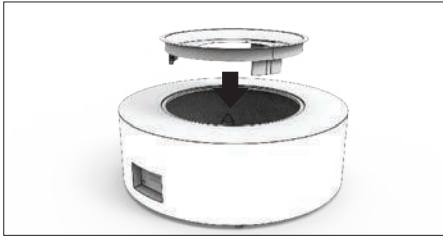
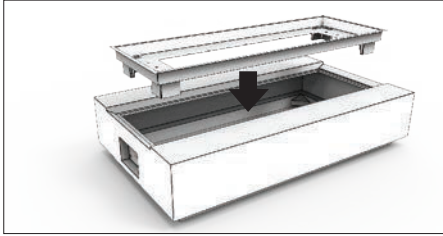

2. Bei Installationen in Innenräumen, das Innenraum-Sicherheitsblech einsetzen. Der Burner darf in Innenräumen nicht ohne eingesetztes Sicherheits-Blech betrieben werden.

Bei Installationen im Außenbereich zu Schritt 3 wechseln.

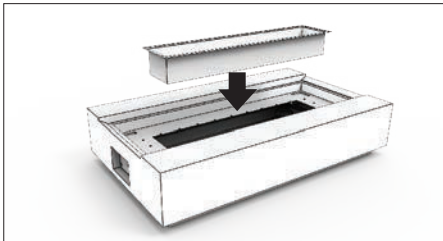

3. Setzen Sie den Burner in das Metallblech ein.

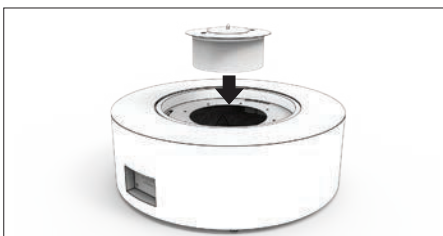
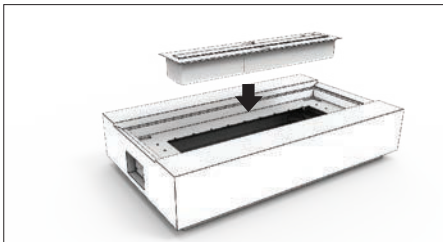

4. Die Glasscheibe einsetzen. (Wenn anwendbar).

Richten Sie jede Glasplatte auf die entsprechenden Fugen im Metallblech aus und bringen Sie diese vorsichtig in Position. Gehen Sie dabei sehr vorsichtig vor, um das Glas nicht zu beschädigen.

Wenn das Gerät als Standardteil enthalten ist (in den USA obligatorisch), darf es nicht ohne installierte Glasscheibe betrieben werden.

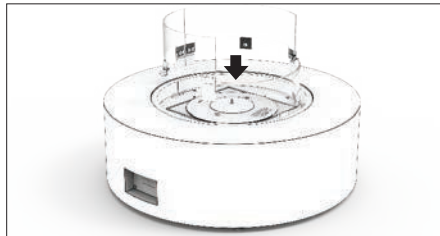
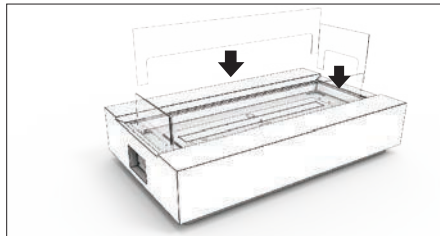

Installation des runden Chaser 38-Glasschutzschirms

4a. Achten Sie darauf, dass alle Eckabdeckungen angebracht sind.

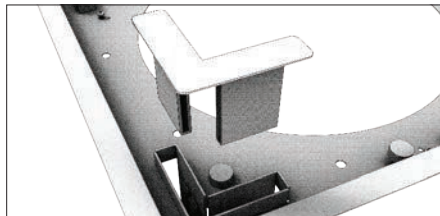

4b. Bringen Sie die drei (3) Metallhalterungen für das Glas an.

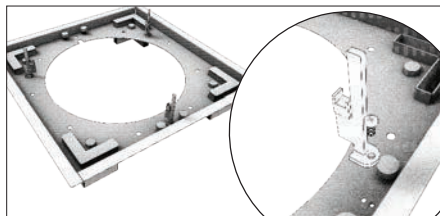

4c. Setzen Sie den Brenner in die Feuerstelle. Platzieren Sie die Kohlepartikel-Glassteine um den Brenner – seien Sie vorsichtig, dass Sie dabei die Brenner-Oberfläche nicht beschädigen oder zerkratzen.

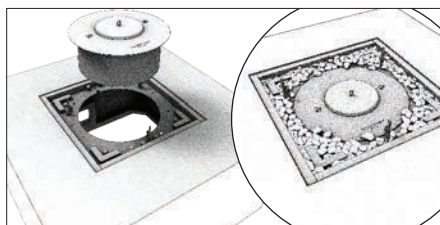

4d. Setzen Sie den Glasschutzschirm vorsichtig auf die drei (3) Metallhalterungen. Achten Sie darauf, dass die Puffer an den Halterungen intakt sind, um eine Beschädigung des Glasschutzschirms zu vermeiden.

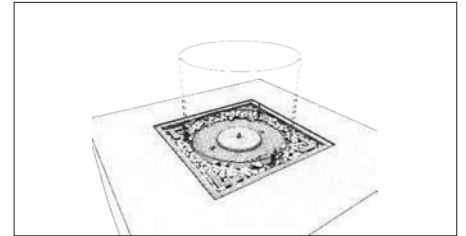

5. Platzieren Sie die Kohlepartikel-Glassteine um den Brenner – seien Sie vorsichtig, dass Sie dabei die Brenner-Oberfläche nicht beschädigen oder zerkratzen.

Platzieren Sie NIEMALS die Kohlepartikel-Glassteine auf dem Brenner oder über der Brenner-Öffnung oder dort, wo sie mit der Flamme während des Betriebs des Brenners in Konflikt geraten könnten.

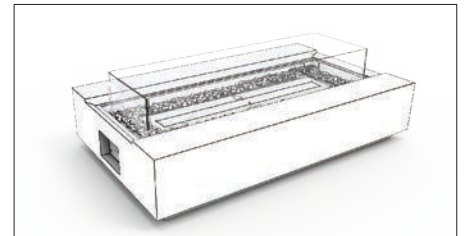

6. Diese Modelle sind mit Bodenhaltewinkeln ausgestattet, damit sie in einer festen Position montiert werden können. Folgen Sie den Anweisungen, die mit den Bodenhaltewinkeln geliefert werden, um die Montage des Produkts abzuschließen.

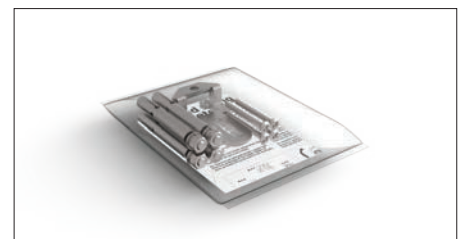

NEHMEN SIE DEN BRENNER ENTSPRECHEND DER BEDIENUNGS- UND INSTALLATIONS-ANLEITUNG, DIE JEDEM BRENNER BEIGEFÜGT IST, IN BETRIEB.

Dégagements pour les Cheminées

Veillez lire ces instructions dans leur intégralité ainsi que le manuel fourni avec votre brûleur avant de faire fonctionner l'appareil. REPORTEZ-VOUS AU MANUEL DANS L'EMBALLAGE DU BRÛLEUR POUR LES DÉGAGEMENTS ET INSTRUCTIONS D'INSTALLATION EN CAS D'UTILISATION AU GAZ NATUREL OU PROPANE.

Ces modèles sont adaptés à une utilisation en extérieur.

Avant l'installation vérifiez que le modèle est positionné conformément aux distances minimales obligatoires décrites ci-dessous.

En cas d'utilisation à l'intérieur, veillez à respecter les dimensions des pièces minimales ci-dessous :

AB8/ AB8(EN)	116m ³ [4096ft ³] par Brûleur
XL900	110m ³ [3884ft ³] par Brûleur

ATTENTION : Assurez-vous que votre cheminée est constamment positionnée loin de matériaux inflammables et d'autres sources d'ignition. Faites très attention à positionner le feu loin des objets / choses susceptibles de se déplacer en raison du vent et des courants d'air. Par exemple, les arbres / branches/ rideaux / papiers, etc.

La base du brûleur au sein du modèle ne doit jamais entrer en contact direct avec des matières inflammables.

Les dégagements latéraux pour les meubles fixes et stables tels que les canapés ou autres meubles de salon doivent toujours rester à un minimum de 600mm de la flamme.

Les dégagements généraux pour des éléments susceptibles de mouvement (par exemple : Arbres) doivent toujours rester à un minimum de 2000mm de la flamme.

Ces produits se caractérisent par un pied qui s'articule à 360 degrés. Régler les pieds en les tournant dans le sens souhaité jusqu'à ce que le modèle soit droit et stable avant utilisation.

L'acier inoxydable rouillera ou corrodera au fil du temps en cas de contamination ou de débris n'ayant pas été nettoyés ou supprimés immédiatement. Utilisez toujours le couvercle du brûleur fourni avec votre modèle pour éviter l'accumulation de poussière et de débris à l'intérieur du brûleur.

Si vous vivez dans des conditions climatiques extrêmes où l'accumulation de neige est probable, l'utilisation du sac d'hiver est impérative afin d'être couvert par la garantie.

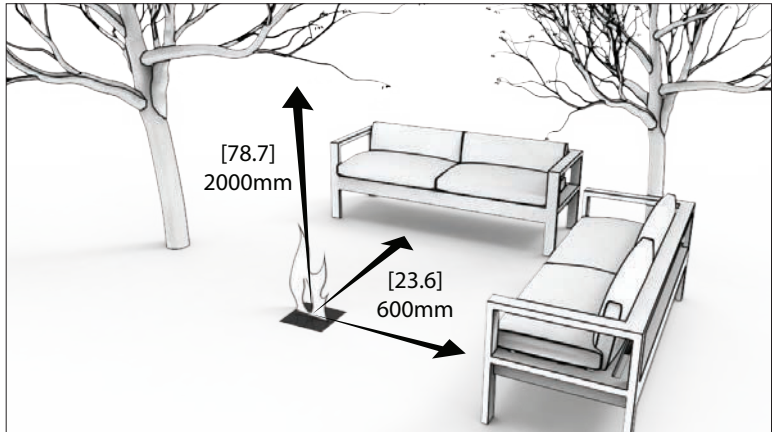

Dégagements Extérieur

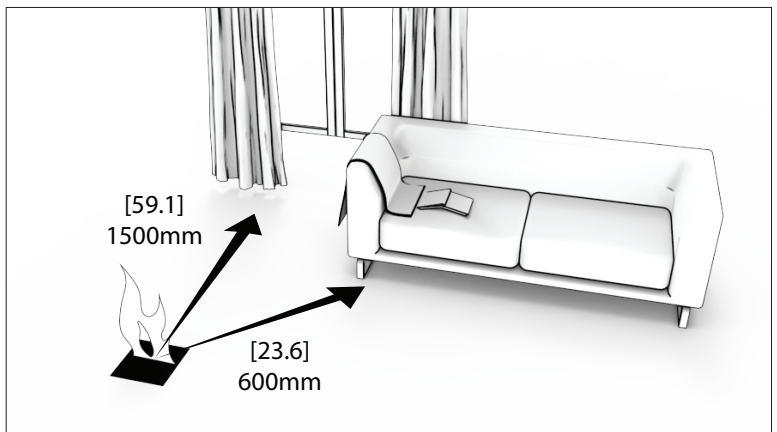

2. Dégagements Intérieur

Installation des Cheminées

1. Insérez le plateau métallique dans la base.

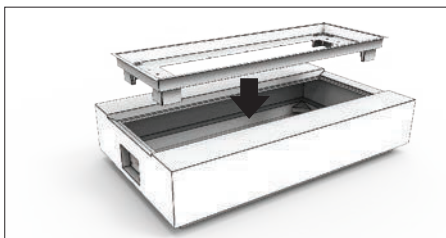

2. Pour les installations à l'intérieur, insérez le plateau de sécurité pour l'intérieur. L'appareil ne doit pas être utilisé à l'intérieur si le plateau de sécurité n'est pas installé.

Pour l'installation à l'extérieur, passez à l'étape 3.

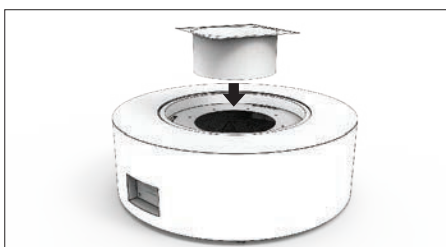
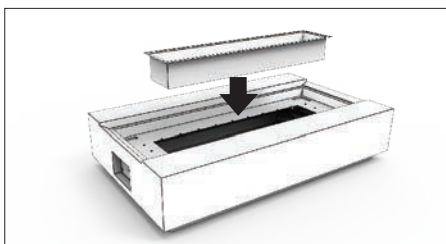

3. Insérez le brûleur dans le plateau métallique.

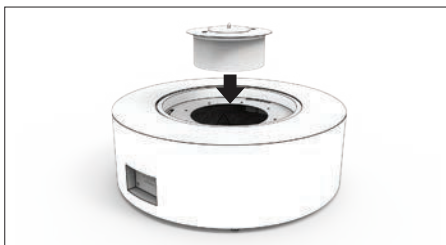
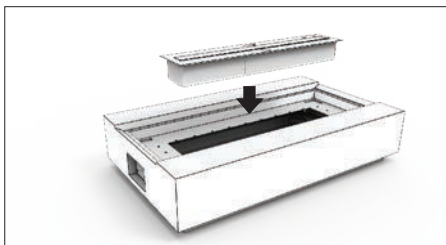

4. Insérez l'écran en verre. (Le cas échéant).

Alignez chaque languette de l'écran de verre avec les fentes prévues à cet effet dans le plateau métallique, puis mettez-la doucement en place. Soyez prudent afin de ne pas briser ou endommager le verre.

S'il est inclus en tant que pièce standard (obligatoire aux États-Unis), l'appareil ne doit pas être utilisé sans l'écran en verre installé.

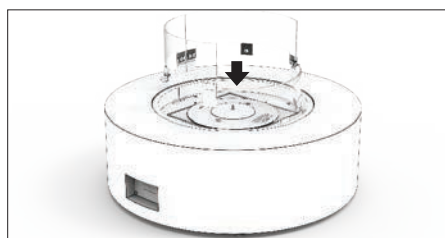
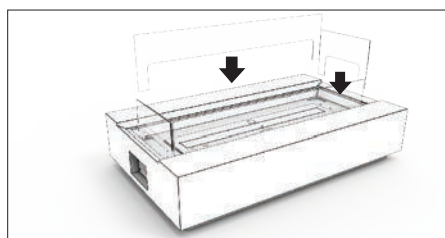

Installation de l'écran rond en verre Chaser 38

4a. Assurez-vous que tous les couvercles d'angle sont en place.

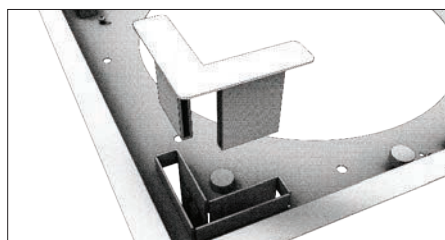

4b. Installez les trois (3) supports métalliques de soutien du verre.

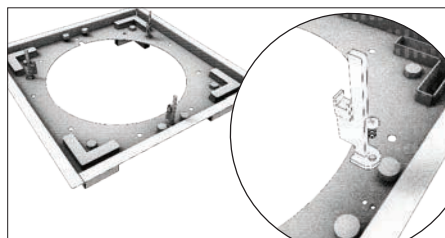

4c. Placez le brûleur dans l'espace dédié. Ajoutez le verre anthracite autour du brûleur. - Attention à ne pas rayer la surface du brûleur.

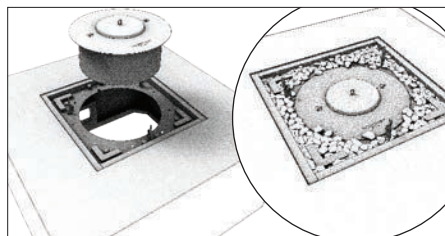

4d. Placez soigneusement le pare-feu en verre sur les trois (3) supports métalliques. Assurez-vous que les butoirs sont intacts sur les supports pour éviter d'endommager le pare-feu en verre.

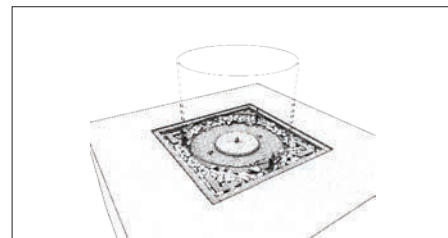

5. Ajoutez le verre anthracite autour du brûleur - Attention à ne pas rayer la surface du brûleur.

Ne placez pas de verres anthracites sur le dessus du brûleur où ils peuvent interférer avec le fonctionnement du brûleur ou la flamme.

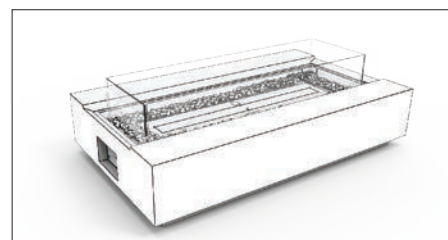

6. Ces modèles sont livrés avec des supports de fixation au sol afin qu'ils puissent être installés dans une position fixe. Suivez les instructions fournies avec les supports de fixation au sol afin de compléter l'installation du produit.

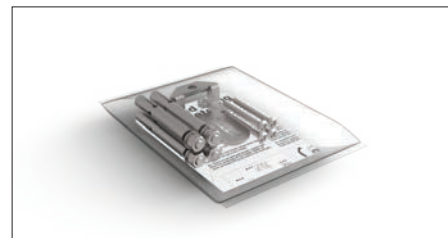

UTILISEZ L'APPAREIL EN ACCORDANCE AVEC LE MANUEL FOURNIS AVEC LE BRÛLEUR.

预留壁炉间隙

使用酒精火炉产品前，请先仔细阅读产品配套的安装，操作和维修指南手册。如果使用煤气或天然气火炉产品，请参照产品包装内提供的操作指南手册进行安装。

此类壁炉可于户外或室内使用。

出于安全考量，产品不适用于可挪动的位置或桌上使用。

安装前，请确保产品的摆放参照以下给出的最小预留间隙。

若在室内使用，请务必注意下方列出的最小房间尺寸要求：

AB8/ AB8(EN)	每个燃烧器最小空间要求 116m ³ [4096ft ³]
XL900	每个燃烧器最小空间要求 110m ³ [3884ft ³]

警告：任何时候请确保壁炉远离易燃物品与明火，如树枝，窗帘，碎纸等可燃物。小心火焰的位置会因为风而引起火苗的晃动点燃物品。

任何情况下，壁炉内的燃烧器都不可与易燃物品直接接触。

对于位置固定的家具，如客厅或户外的环境下，任何情况下请确保壁炉产品与家具保留至少60厘米以上的间距。

对于壁炉上方可飘动的物件，如树木等，任何情况下请确保壁炉与此类物品保留至少2米以上的间距。

此类产品附带360°可调节脚垫。通过调整脚垫的角度可确保您在水平与稳定的最佳效果下安全使用火炉产品。

燃烧器表面上的污渍如不常清理，不锈钢的表面会随着日常的使用而缓慢生锈。请务必使用您所购买产品附带的防护罩，以避免燃烧器内灰尘和碎屑堆积。

如您居住地区的会有积雪，气候条件较为极端，则有必要使用冬季套装，以便享受质保。

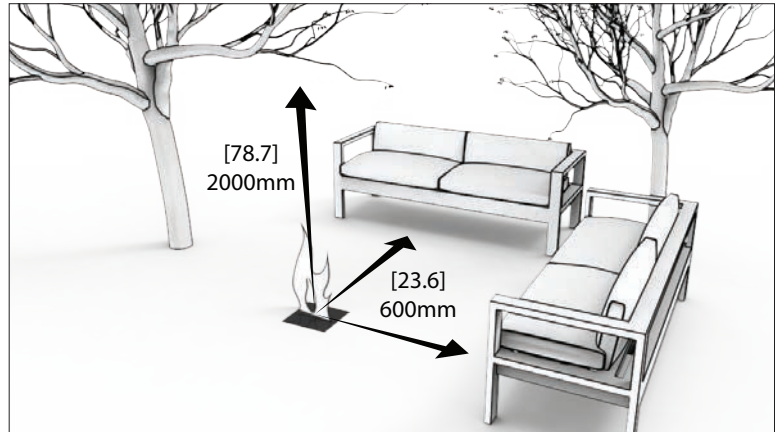

户外安装

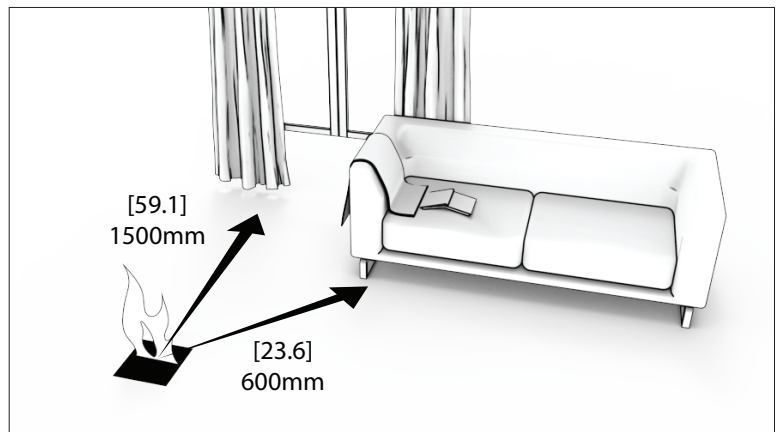

室内安装

安装壁炉

1. 将金属托盘放入底座中。

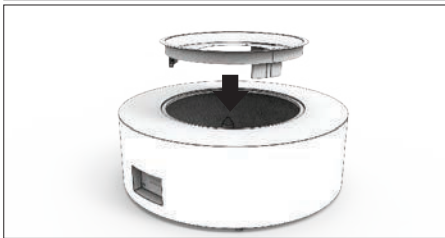
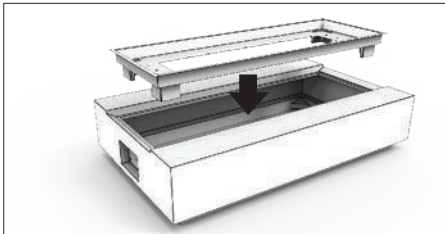

2. 若要进行室内安装，请放入室内安全托盘。在没有安装安全托盘的情况下，请勿在室内使用产品。

若要进行室外安装，请转至步骤3。

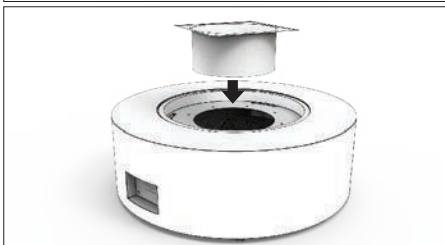
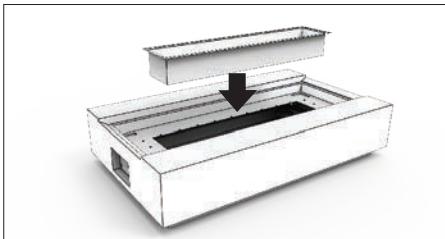

3. 将燃烧器放入金属托盘。

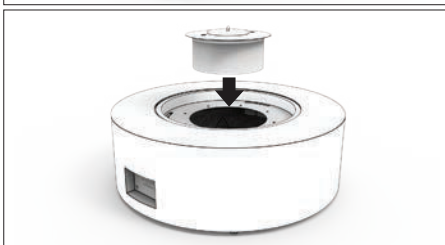
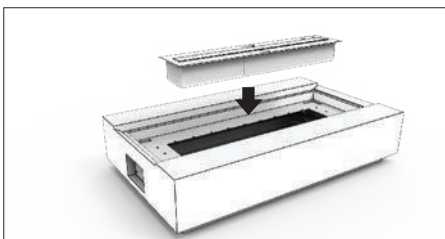

4. 放入挡风玻璃。(如适用)。

将每个玻璃幕墙标签与金属托盘上的指定槽对齐，然后轻轻放置到位。小心操作，以免打碎或损坏玻璃。

如果玻璃屏是标配零件（在美国是强制性的），则在未安装玻璃屏的情况下不得运行该设备。

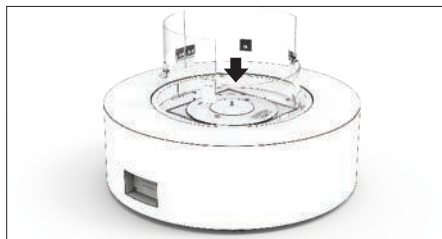
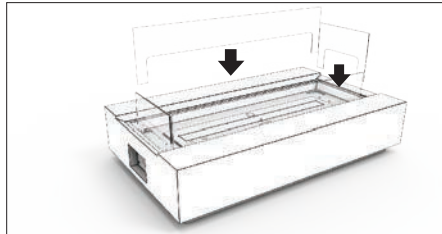

安装 Chaser 38 圆形玻璃板

4c. 确保所有角盖都已打开。

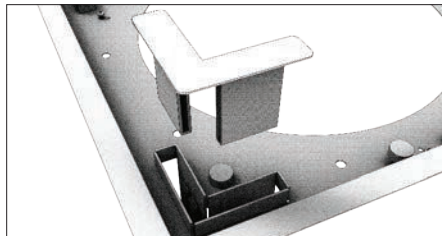

4b. 安装三 (3) 个玻璃支撑金属 支架。

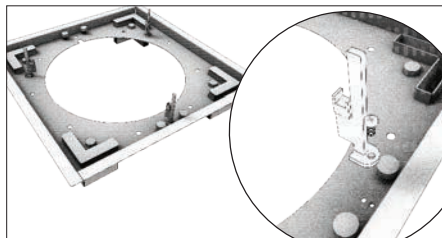

4c. 安放燃烧器至火炉内。在燃烧器周围摆放黑色高温结晶炭 - 小心挪动避免划伤燃烧器的表面。

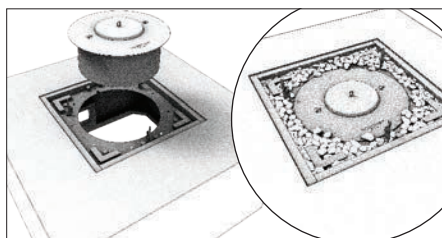

4d. 小心地将玻璃炉挡放在三 (3) 个金属支架上。确保支架上的缓冲垫完好无损，以防止损坏玻璃炉挡。

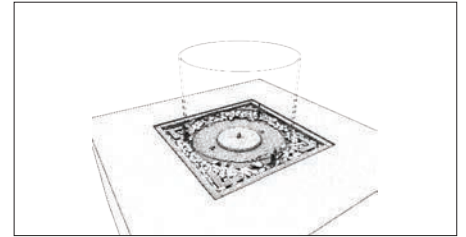

5. 在燃烧器周围摆放黑色高温结晶炭 - 小心挪动避免划伤燃烧器的表面。

请勿摆放玻璃木炭石在燃烧器的正上方或是会影响燃烧器正常运作的位置。

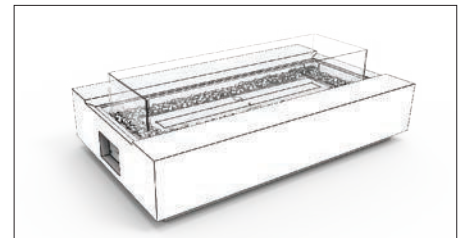

6. 此类产品配有地钉紧固件，可以固定位置安装。请参阅紧固件安装说明完成安装。

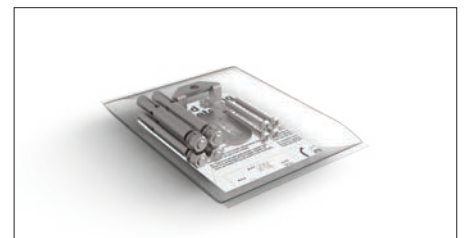

壁炉安装（包含燃烧器）请根据安装操作手册。

Sicurezza Caminetti

Leggere il manuale di istruzioni per l'uso prima di operare un prodotto EcoSmart™ Fire.

FARE RIFERIMENTO AL MANUALE OPERAZIONI NELLA SCATOLA DEL BRUCIATORE PER DISTANZE MINIME E INSTALLAZIONE IN CASO DI UTILIZZO DI PROPANO O GAS NATURALE.

Quando si utilizza il bioetanolo come fonte di carburante, questo modello è adatto per uso interno ed esterno.

Prima dell'installazione assicurarsi che il modello sia posizionato in conformità con le distanze minime obbligatorie indicate di seguito.

Se utilizzato in ambienti interni, assicurarsi di prestare attenzione alle dimensioni minime della stanza sotto elencate

AB8/ AB8(EN)	116m ³ [4096ft ³] per bruciatore
XL900	110m ³ [3884ft ³] per bruciatore

ATTENZIONE: Assicurarsi che il fuoco sia posizionato lontano da materiali infiammabili e altre fonti di ignizione in ogni momento. Prestare molta attenzione a posizionare il fuoco lontano da oggetti che possono muoversi a causa di vento e correnti d'aria. Per esempio alberi / rami / carta e simili.

La base del bruciatore all'interno del modello non deve mai entrare in contatto diretto con materiali infiammabili.

Distanze laterali a mobili fissi e oggetti stabili che non sono soggetti a movimento come salotti o mobili da giardino devono rimanere un minimo di 600mm [23.6in] lontano dalla fiamma in ogni momento.

Distanze in eccesso verso oggetti suscettibili di movimento (ad es. Alberi) deve rimanere a una distanza minima di 2000mm [78.7in] dalla fiamma in ogni momento.

Questi prodotti sono dotati di piedi articolati regolabili in altezza a 360 °. Regolare i piedi ruotandoli in entrambe le direzioni fino a raggiungere un modello perfettamente livellato e stabile prima di operare.

L'acciaio inossidabile si arrugginisce o si corrode nel tempo se la contaminazione o i detriti non vengono puliti o rimossi immediatamente. Utilizzare sempre il coperchio del bruciatore incluso nel modello per evitare l'accumulo di polvere e detriti all'interno del bruciatore.

Se abitate in condizioni climatiche estreme dove è probabile che nevichi, è obbligatorio usare la Borsa Invernale per essere coperti dalla garanzia.

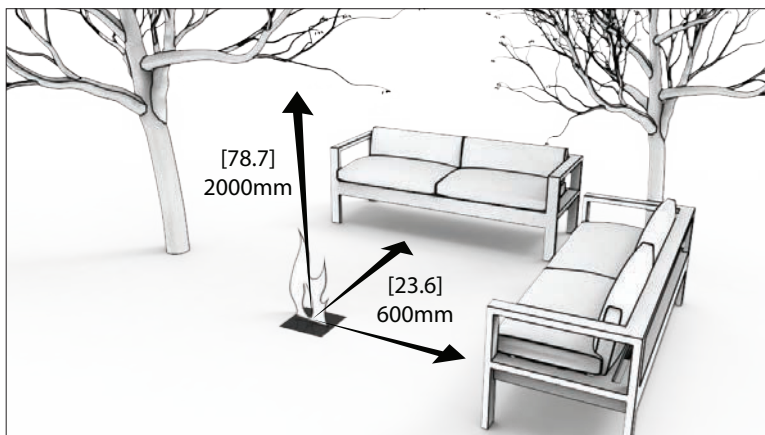

1. Distanze esterne

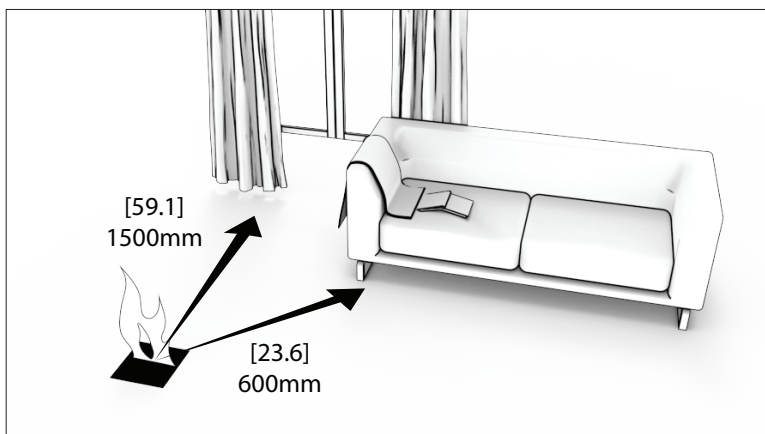

2. Distanza interna

Installazione Caminetti

1. Inserire la vaschetta di metallo nella base.

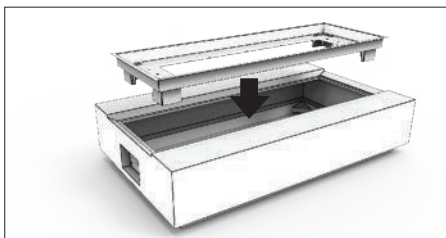

2. Per Installazioni (in località - please remove) interne inserire la Vaschetta di Sicurezza. L'apparecchio non deve essere utilizzato in località interne se non è stata installata la Vaschetta di Sicurezza.

Per installazioni all'aperto passare alla Fase 3.

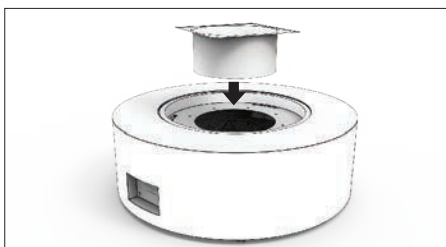
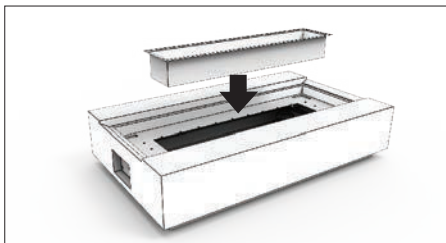

3. Inserire il Bruciatore nella vaschetta di metallo.

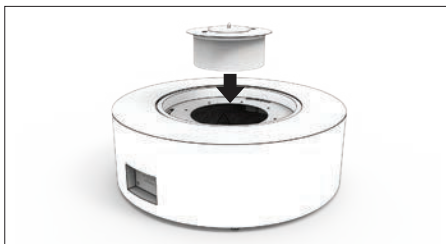
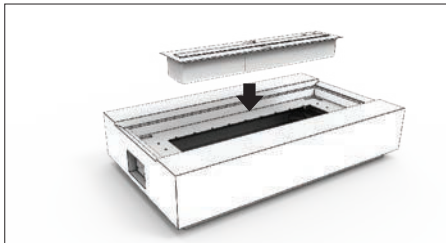

4. (Se applicabile) Inserire lo schermo.

Allineare ogni linguetta dello schermo di vetro con le apposite fessure nel vassoio in metallo. Esercitare pressione con cautela al fine di non rompere o danneggiare il vetro.

Se incluso come parte standard (obbligatorio negli USA), l'apparecchio non deve essere messo in funzione senza che lo schermo in vetro sia stato installato.

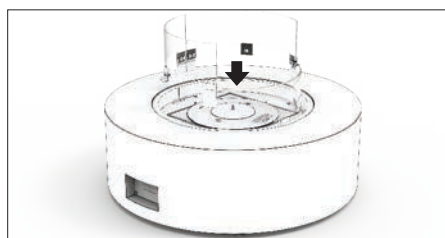
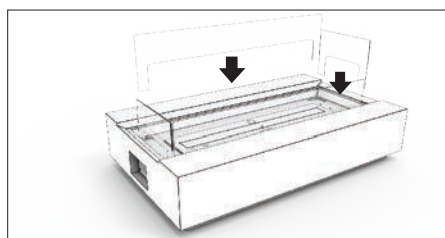

**Installare lo schermo in vetro rotondo
Chaser 38**

4a. Assicurarsi che tutte le coperture degli angoli siano inserite.

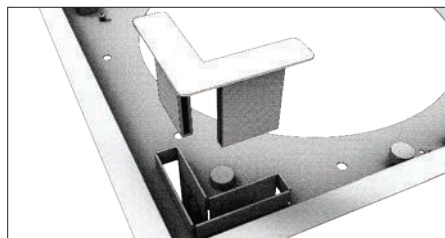

4b. Installare le tre (3) staffe metalliche di supporto del vetro.

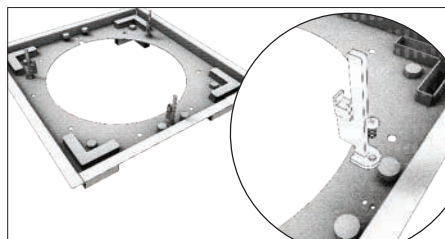

4c. Inserire il bruciatore nel modello.

Aggiungere il carbone di vetro attorno al bruciatore - fare attenzione a non graffiare la superficie del bruciatore. .

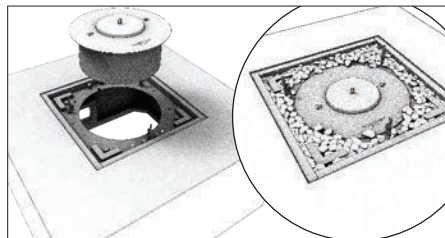

4d. Posizionare con cura lo schermo in vetro del bruciatore sulle tre (3) staffe metalliche. Assicurarsi che i supporti delle staffe siano intatti per evitare di danneggiare lo schermo in vetro del bruciatore.

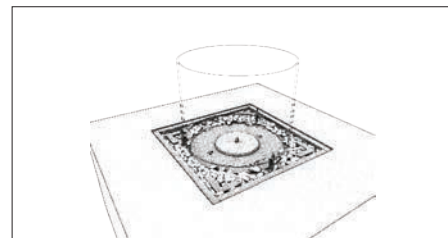

5. Aggiungere il carbone di vetro attorno al bruciatore - fare attenzione a non graffiare la superficie del bruciatore.

Non posizionare il carbone di vetro sul bruciatore o dove possono interferire con il funzionamento del bruciatore o della fiamma.

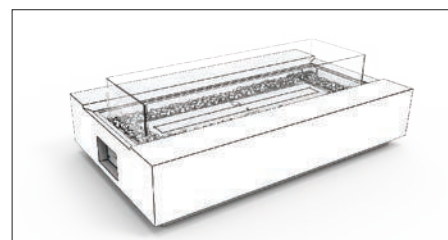

6. Questi modelli sono dotati di staffe di fissaggio (Ground Fixing Brackets) a terra in modo che possano essere installati in una posizione fissa. Seguire le istruzioni fornite con le staffe di fissaggio a terra per completare l'installazione del prodotto.

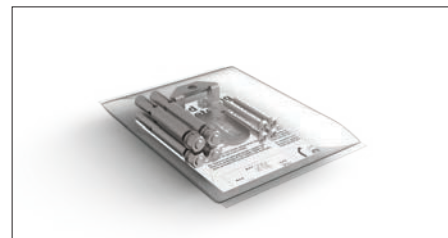

**OPERARE IL BRUCIATORE SECONDO IL
MANUALE DI OPERAZIONE INCLUSO.**

Distancias mínimas para las Chimeneas

Por favor, lea estas instrucciones y el manual de operaciones del quemador suministrado con el mismo completamente antes de hacerlos funcionar. Diríjase al manual de operaciones en la caja del quemador para distancias mínimas e instrucciones de instalación si se usa propano o gas natural.

Estos modelos están adecuados para uso en el exterior cuando se utiliza bioetanol como combustible.

Antes de la instalación asegúrese de que el modelo este posicionado de acuerdo con las distancias mínimas indicadas abajo.

Asegúrese de prestar atención a las medidas mínimas de habitaciones si utilizado en espacios interiores, a continuación:

AB8/ AB8(EN)	116m ³ [4096ft ³] por quemador
XL900	110m ³ [3884ft ³] por quemador

PRECAUCIÓN: Asegúrese de que su chimenea esté situada lejos de materiales inflamables u otras fuentes de ignición en todo momento. Preste toda la atención al posicionamiento de la chimenea lejos de cosas que puedan moverse como resultado del viento o corrientes. Por ejemplo árboles/ramas/cortinas/papel y similares.

La base del quemador nunca debe entrar en contacto directo con materiales inflamables.

El espacio libre lateral entre la chimenea y mobiliario fijo o estable debe ser de al menos 600mm hasta la llama en todo momento.

El despeje o la distancia vertical entre la llama y cualquier objeto que sea susceptible a movimiento (árboles o plantas) tiene que ser un mínimo de 2000mm [78.7] en todo momento.

Estos productos incluyen pies articulados en 360° de altura ajustable. Ajuste estos pies girándolos en la dirección apropiada hasta obtener una posición nivelada y estable antes de hacerlos funcionar.

El acero inoxidable puede mostrar restos de corrosión con el tiempo si la contaminación o restos no son limpiados inmediatamente. Siempre utilice la tapa del quemador incluida con su modelo para evitar que se acumule polvo y escombros adentro del quemador.

Si vive en condiciones climáticas extremas donde es probable que se acumule nieve, es imprescindible utilizar el cubierta de invierno para estar cubierto por la garantía.

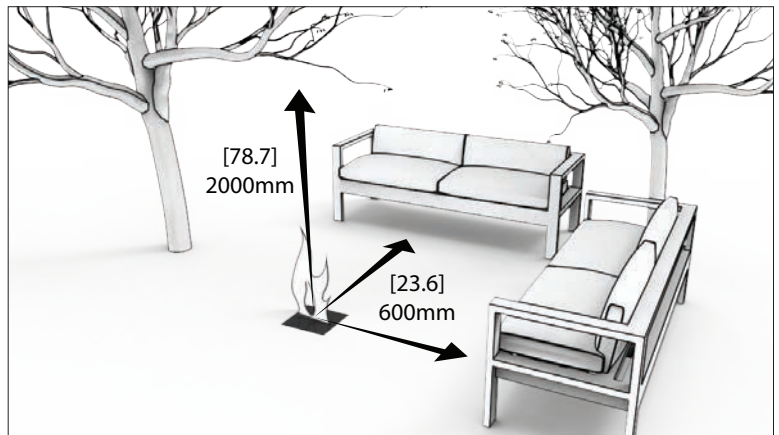

Espacio libre en exterior

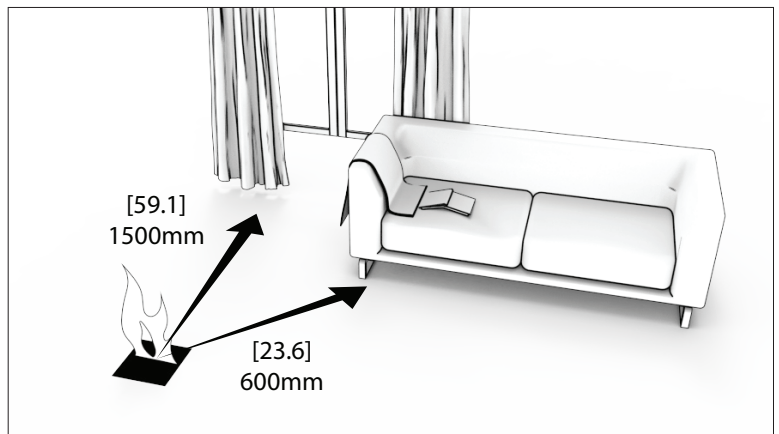

Espacio libre en interior

Instalación de la chimenea

1. Inserte la bandeja de metal en la base.

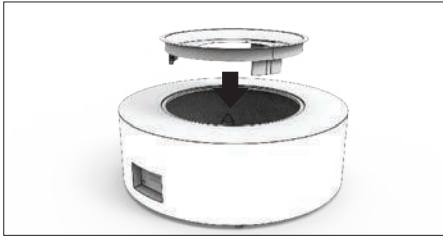
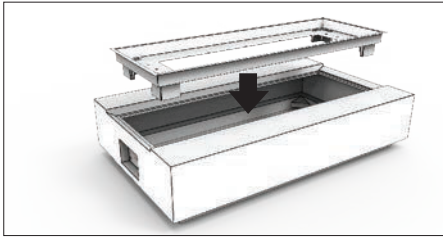

2. Inserte el doble fondo de seguridad para instalaciones interiores. El aparato no debe estar utilizado en espacios interiores sin el doble fondo de seguridad instalado.

Para la instalación en el exterior, vaya al Paso 3.

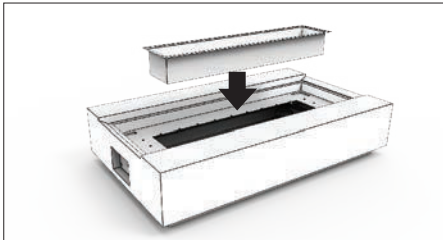

3. Inserte el quemador en la bandeja de metal.

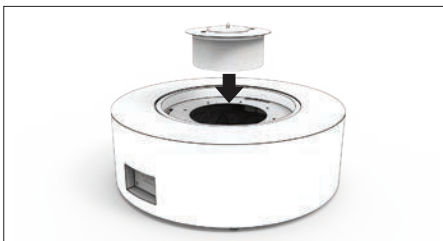
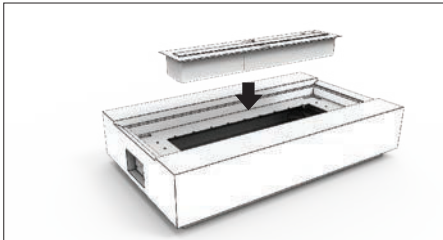

4. Inserte la pantalla de vidrio. (Si se aplica).

Alinee cada pestaña de la pantalla de vidrio con las ranuras designadas en la bandeja de metal, coloque suavemente en su posición. Tenga precaución para no fracturar o dañar el vidrio.

Si se incluye como pieza estándar (obligatorio en EE. UU.), el aparato no debe utilizarse sin la pantalla de cristal instalada.

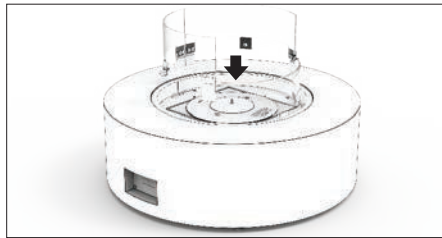
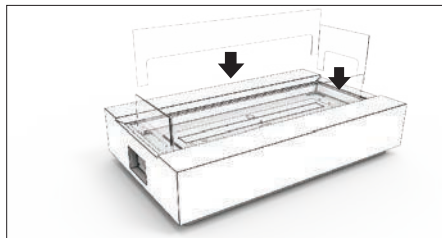

Installation de la vitre ronde Chaser 38

4a. Asegúrese de que todas las cubiertas de las esquinas estén puestas.

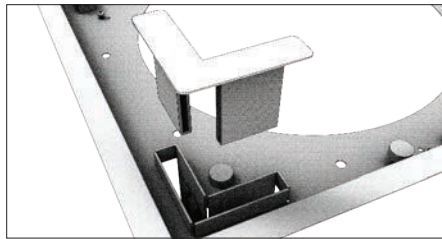

4b. Installez les trois (3) supports métalliques pour soutenir la vitre.

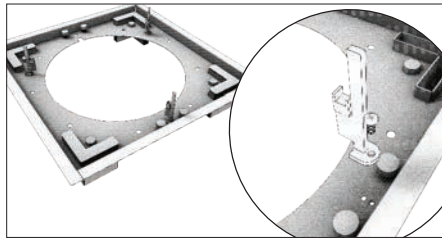

4c. Inserte el quemador en el modelo. Añade el vidrio antracita alrededor del quemado - Precaución de no rasgar la superficie del quemador.

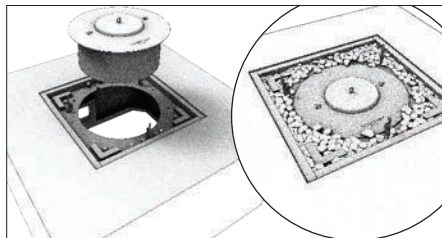

4d. Coloque con cuidado la pantalla de cristal contra incendios en los tres (3) soportes metálicos. Asegúrese de que los topes están intactos en los soportes para evitar dañar la pantalla de cristal contra incendios.

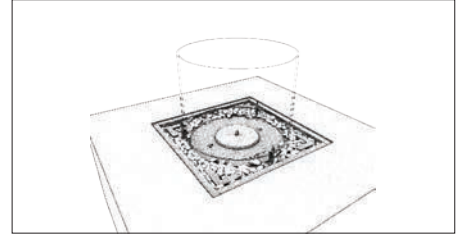

5. Añade el vidrio antracita alrededor del quemado - Precaución de no rasgar la superficie del quemador.

No coloque ningún vidrio antracita sobre el quemador. Esto puede causar interferencia con la llama y/o el uso apropiado del quemador.

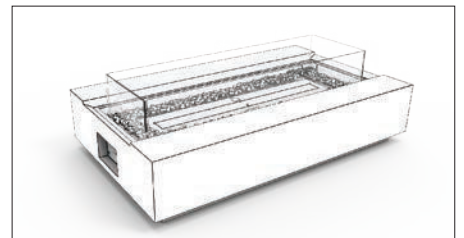

6. Estos modelos vienen con soportes de fijación de tierra para que puedan instalarse en una posición fija. Siga las instrucciones suministradas con los soportes de fijación de tierra para completar la instalación del producto.

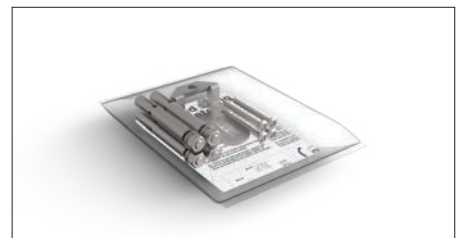

SIEMPRE USE DE ACUERDO CON EL MANUAL OPERACIONAL, INCLUIDO CON EL QUEMADOR.



MAD Design Group

Showrooms 3 & 4, 40-42 O'Riordan Street

Alexandria NSW 2015 Australia

Tel: +61 2 9997 3050 Email: info@maddesigngroup.com

REV0920